



# LA COLLINA

PRODUKTDATEN

PRODUCT INFORMATION  
INFORMATION PRODUITS

**Bretz**  
TRUE CHARACTERS



Z 111LI LA COLLINA ▶ 304 CM ◀ 198 CM ▲ 99 CM  
STOFF · FABRIC · TISSU 65 BOH02 / 68 5519 / 66 8439

## NOTHING IS TOO MUCH TROUBLE IF IT TURNS OUT THE WAY IT SHOULD

Ein normaler Tag beginnt bei mir morgens um 5 Uhr und endet nie vor Mitternacht. Das ist mein ganz persönlicher Traum, denn ich führe mein eigenes Fine-Dining-Restaurant. Hier habe ich alles in der Hand, vom Einkauf der besten Zutaten auf dem Großmarkt bis zur kreativen Rezeptentwicklung und dem Kontakt zu meinen Gästen. Ich liebe diese Tage mit Action von früh bis spät und dann am Ende diesen Moment der vollkommenen Ruhe auf meiner Couch. **Welcome to my soul-kitchen!**

### FACTS & HIGHLIGHTS

- Klassisch fließende Form neu interpretiert
- Geschwungene, hohe Rückenlehne verleiht einzigartige Silhouette
- Gut zur individuellen Sitzlandschaft kombinierbar
- Lange Sitzkissen ermöglichen entspanntes Liegen und schlafen
- Abziehbare Sitzkissen



A 111 LA COLLINA  
▶ 105 CM ◀ 94 CM ▲ 125 CM  
STOFF · FABRIC · TISSU 65 BOH02 / 68 5519

C 111 LA COLLINA ▶ 68 CM ◀ 50 CM ▲ 44 CM  
STOFF · FABRIC · TISSU 65 BOH02



X 111LI LA COLLINA ▶ 198 CM ◀ 106 CM ▲ 99 CM  
SITZKISSEN ▶ 171 CM ◀ 81 CM  
STOFF · FABRIC · TISSU 65 BOH02



Z 111RE LA COLLINA ▶ 304 CM ▾ 198 CM ▲ 99 CM  
STOFF · FABRIC · TISSU 66 8430

## NOTHING IS TOO MUCH TROUBLE IF IT TURNS OUT THE WAY IT SHOULD

My typical day starts at five in the morning and never ends before midnight. And it's a dream come true for me, because I run my very own fine dining restaurant. I keep my finger on the pulse from dusk 'til dawn – from buying the choicest ingredients at the market to creative recipe design and mingling with my guests. I love these long, action-filled days and evenings – and then this moment of absolute, uninterrupted serenity on my couch. **Welcome to my soul-kitchen!**

### FACTS & FEATURES

- A traditional, flowing form – reimagined
- A lofty, curvilinear backrest creates a silhouette all it's own
- Ideal for combining into an individual seating arrangement
- Long seat cushions are perfect for lounging or sleeping
- Removable seat cushions



A 111 LA COLLINA  
▶ 105 CM ▾ 94 CM ▲ 125 CM  
STOFF · FABRIC · TISSU 66 8430 / 67 2635



F-VRE 111 LA COLLINA ▶ 304 CM ▼ 240 CM ▲ 99 CM  
STOFF · FABRIC · TISSU 65 BOH02 / 68 5519 / 65 7949

## UN HAVRE DE PAIX POUR SE RESSOURCER AU QUOTIDIEN

Ma journée de travail commence à 5 heures du matin et ne se termine jamais avant minuit. C'est ce dont j'ai toujours rêvé, puisque que je dirige mon propre restaurant gastronomique. Ici, je contrôle tout, l'achat des meilleurs produits au marché, l'élaboration de recettes originales et le contact avec mes hôtes. J'aime ces journées actives du matin au soir et puis ce moment de détente absolue à la fin de la journée sur mon canapé. **Welcome to my soul-kitchen!**

### CARACTÉRISTIQUES & HIGHLIGHTS

- Le haut dossier galbé lui confère une silhouette unique
- Forme fluide classique entièrement réinterprétée
- Facilement intégrable à l'espace canapés individuel
- Les coussins allongés des sièges invitent à la détente et au repos prolongés
- Housses de siège amovibles



A 111 LA COLLINA ▶ 105 CM ▼ 94 CM ▲ 125 CM  
STOFF · FABRIC · TISSU 65 BOH02



F 111 LA COLLINA ▶ 240 CM ▼ 106 CM ▲ 99 CM  
STOFF · FABRIC · TISSU 65 BOH02



COLLECTION LA COLLINA



G 111RE LA COLLINA ► 318 CM ▼ 106 CM ▲ 99 CM  
STOFF · FABRIC · TISSU 65 BOH02 / 68 5519 / 65 7949



F 111 LA COLLINA ► 240 CM ▼ 106 CM ▲ 99 CM  
STOFF · FABRIC · TISSU 66 8480



X 111RE LA COLLINA ► 198 CM ▼ 106 CM ▲ 99 CM  
STOFF · FABRIC · TISSU 65 BOH02



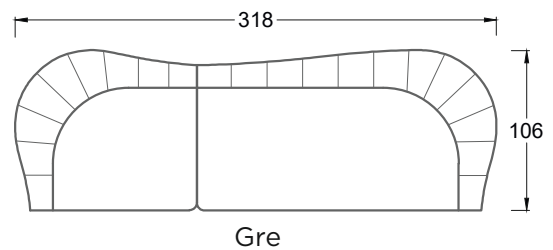
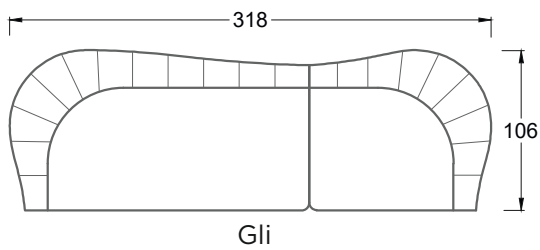
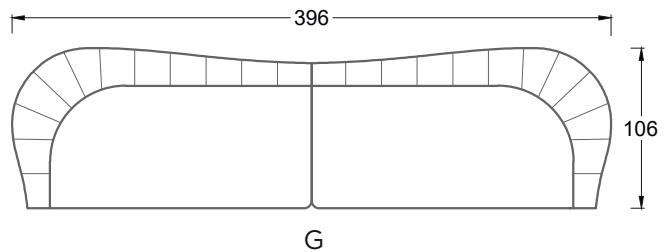
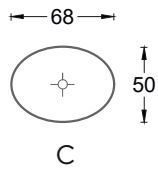
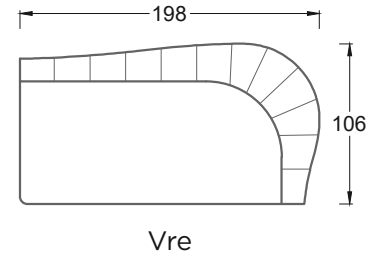
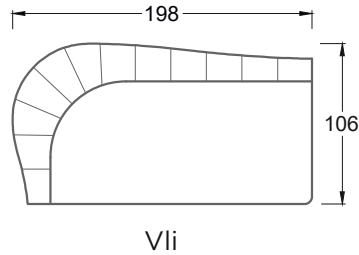
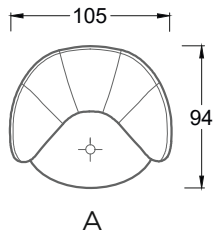
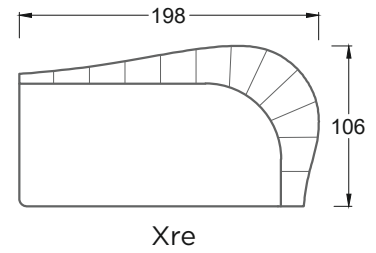
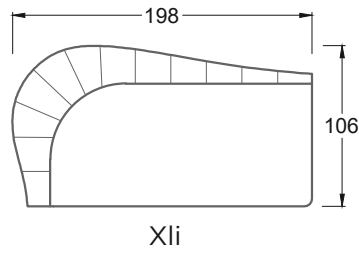
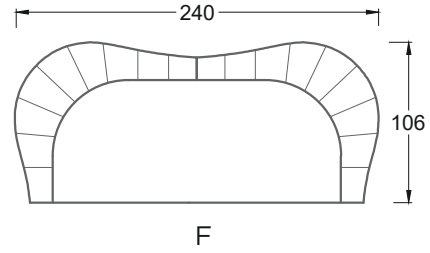
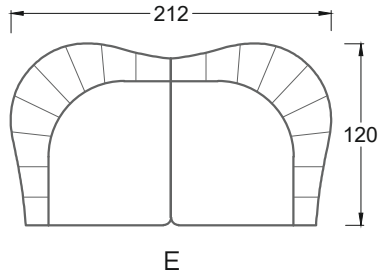
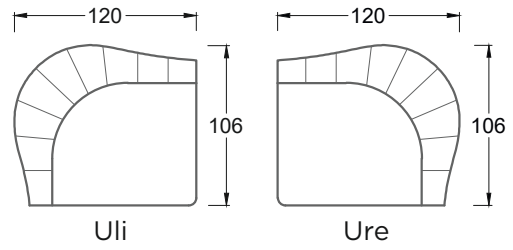
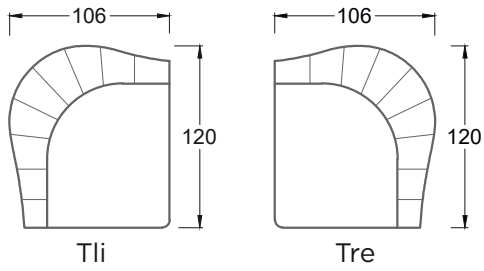



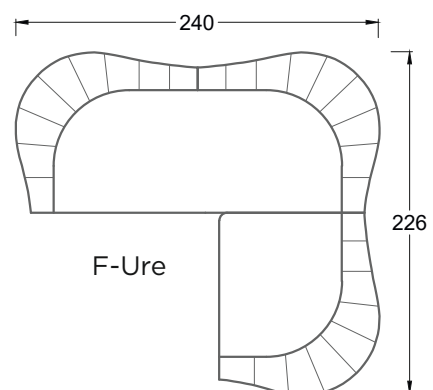
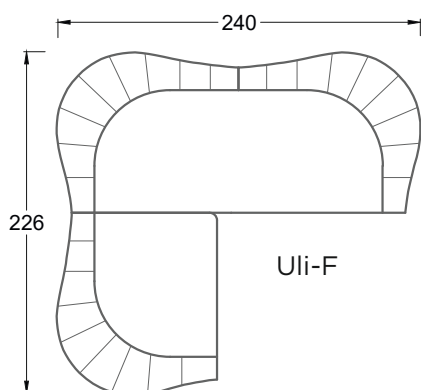
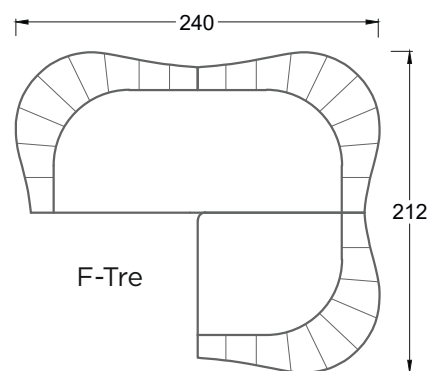
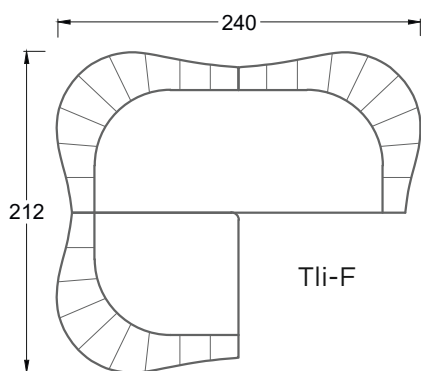
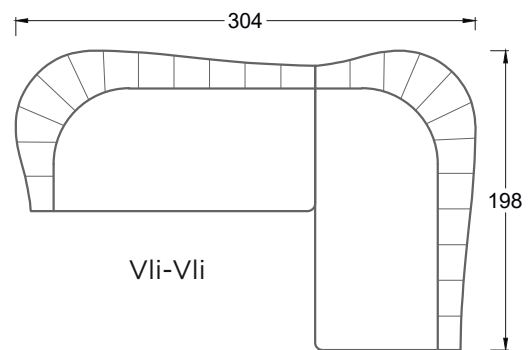
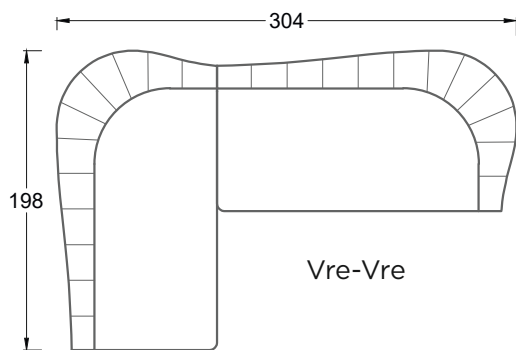
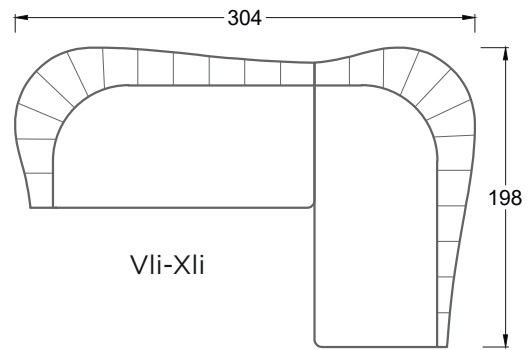
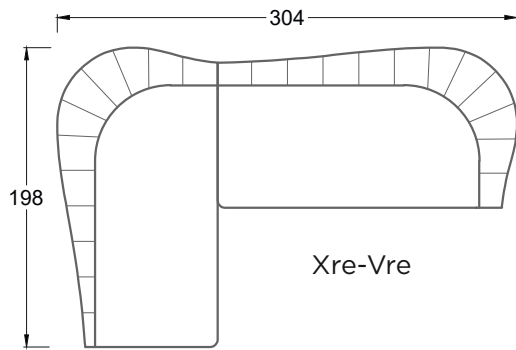
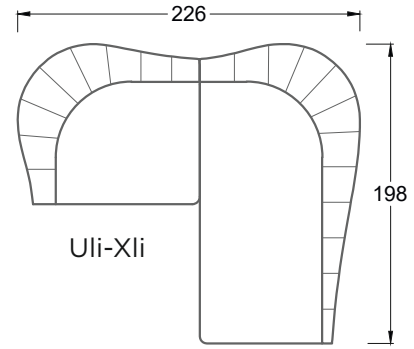
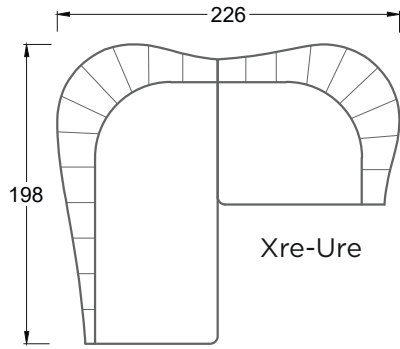

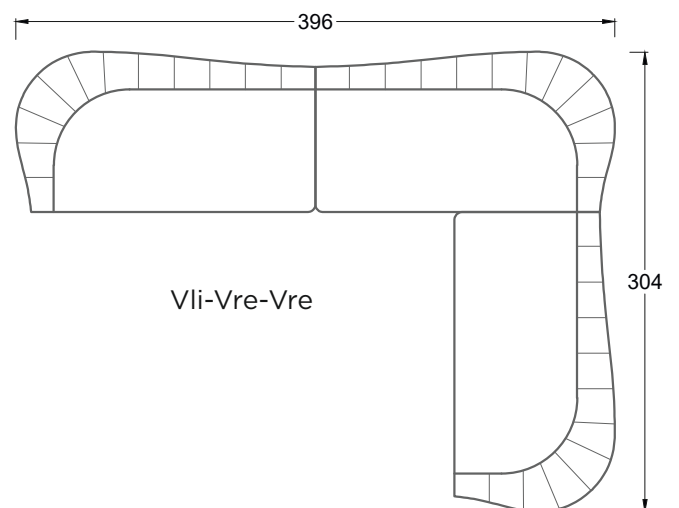
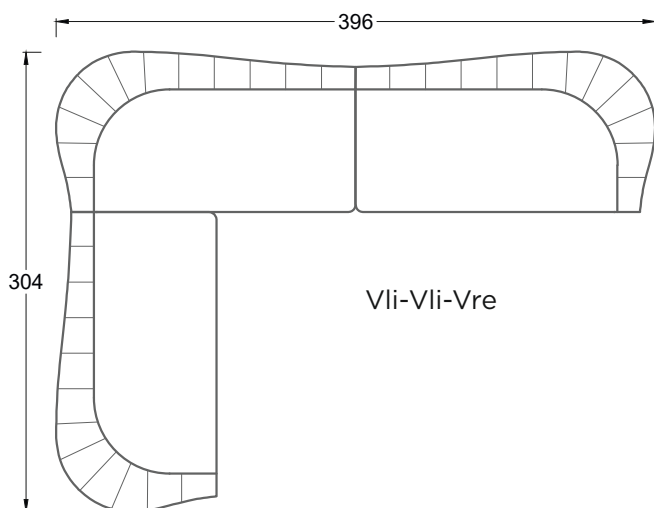
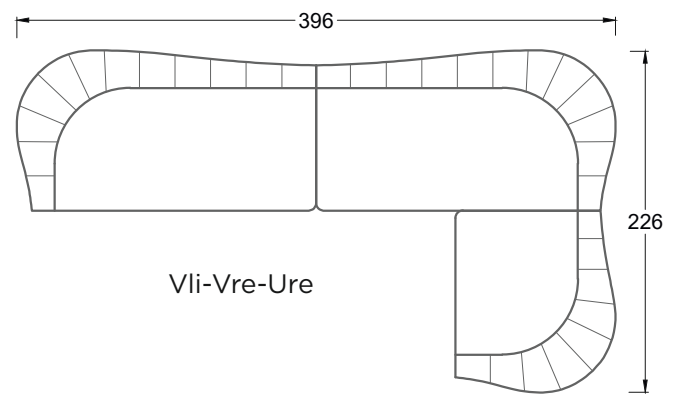
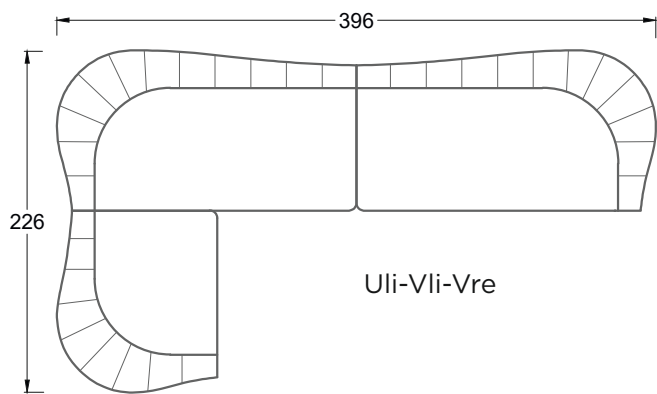
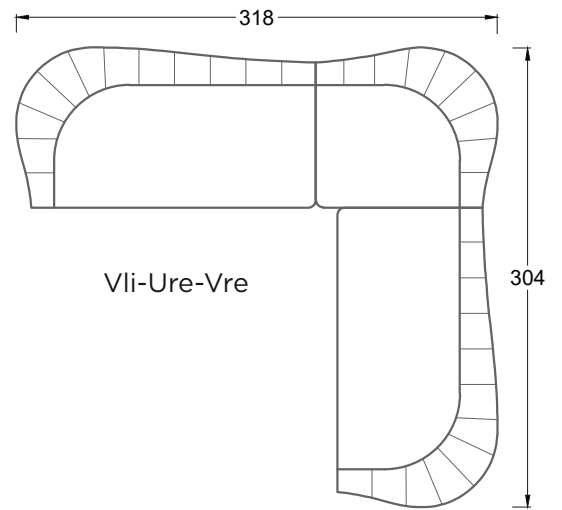
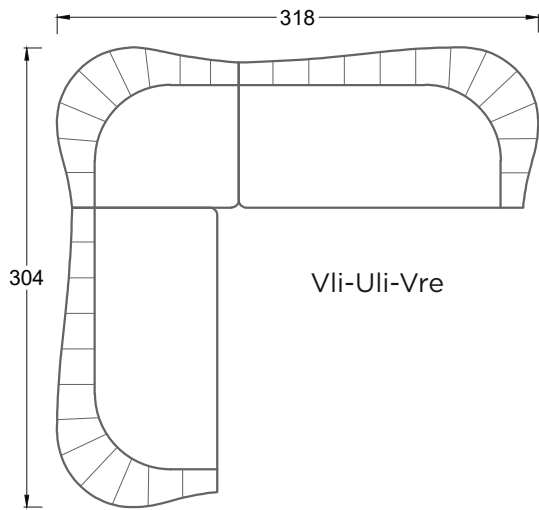
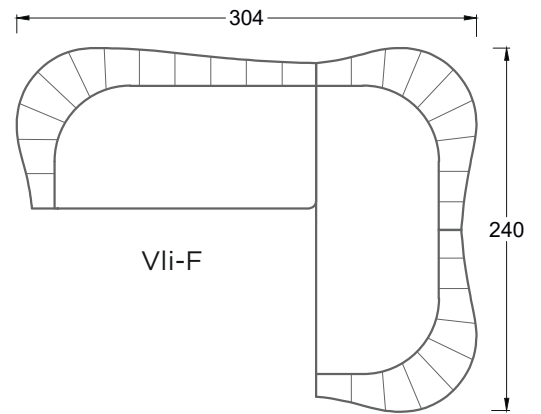
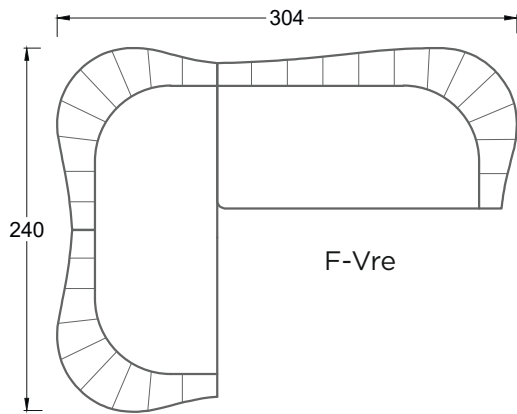

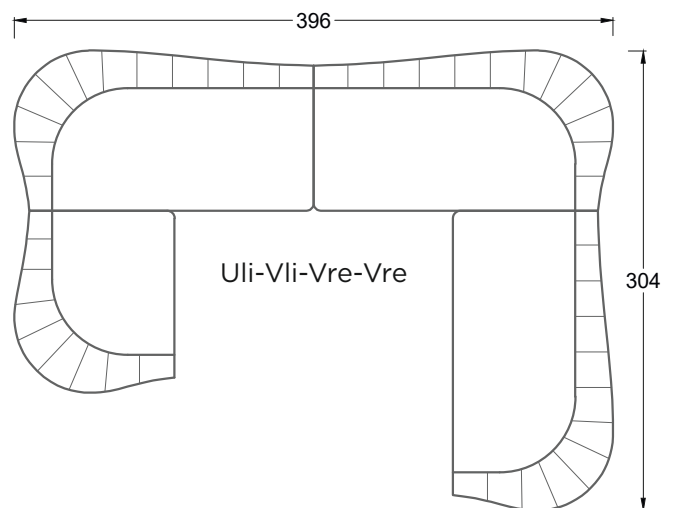
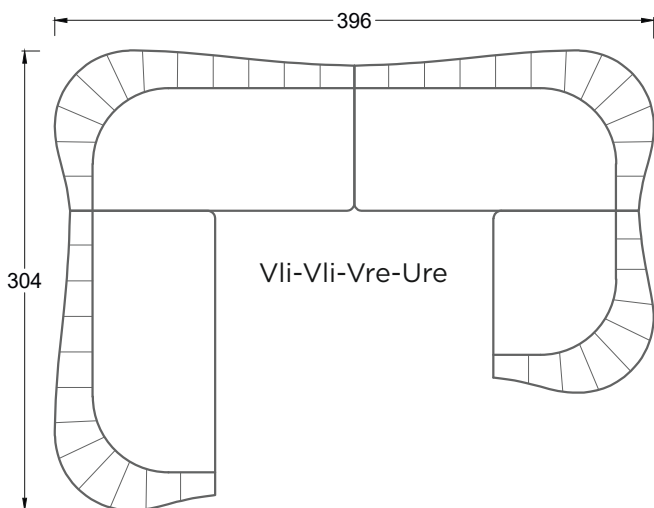
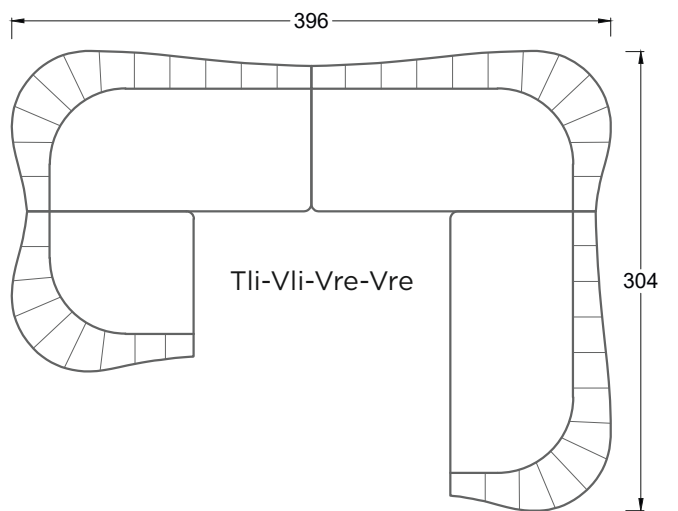
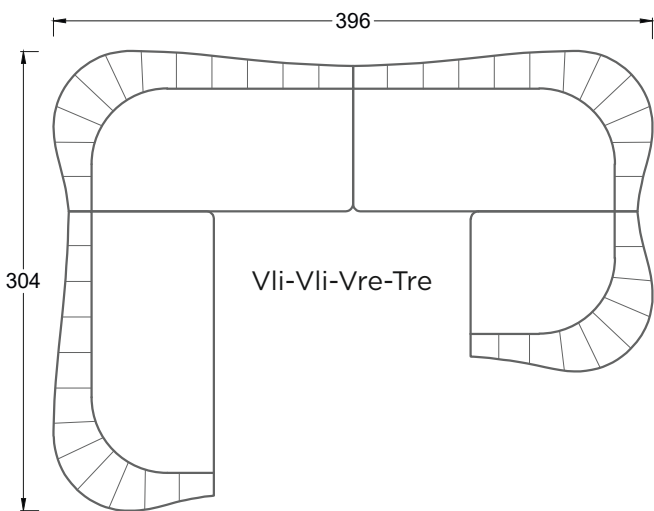
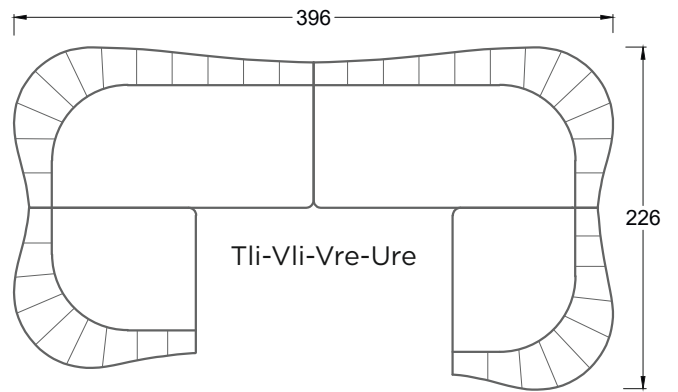
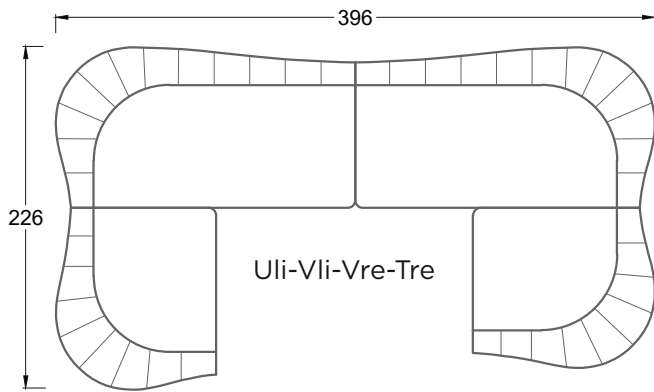
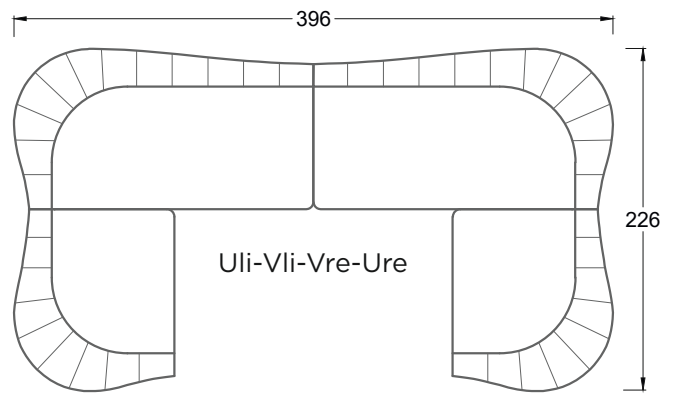
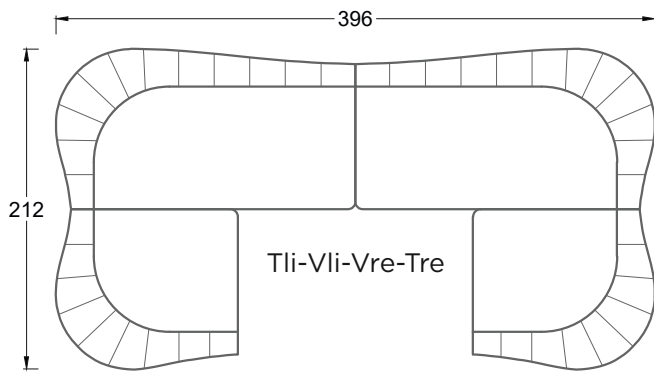



**BRETZ  
GERMAN MANUFACTURE  
SINCE 1895**

**HEAD OFFICE & SHOWROOM:**  
ALEXANDER-BRETZ-STR. 2  
D-55457 GENSINGEN  
TEL +496727-895-0  
E-MAIL [INFO@BRETZ.DE](mailto:INFO@BRETZ.DE)

**BRETZ SALES FLAGSHIPS & PARTNERS:**  
[BRETZ.DE](http://BRETZ.DE)

**Bretz**  
TRUE CHARACTERS