

## ESSTISCHE

4-Fuß-Esstisch  
(in zwei Breiten – 95 und 105 cm)



L 140 (VEN-351100) bis  
220 (VEN-351150) | H 76,0

F6 Ansteckplatte  
VEN-530100/105/110  
B 95,0/105 | L 50,0 | H 3,0

4-Fuß-Esstisch mit Verlängerungsfunktion  
(in zwei Breiten – 95 und 105 cm)



L 180 (VEN-361100) bis  
220 (VEN-361175) | H 76,0

F4 - Synchronauszug mit  
flacher Klappmechanik  
Verlängerung +60 | +80

## SCHALEN- STUHL



VEN-455100  
B 50,0 | H 86,5  
T 59,0

## BÄNKE

Einzelbank

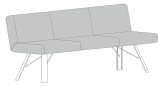

L 140 (VEN-402100) bis  
220 (VEN-402140)  
H 83,2 | T 65,0

Eckbank

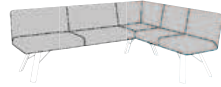

L 165 (VEN-403100) bis  
290 (VEN-403560)  
H 83,2 | T 65,0

## VITRINEN

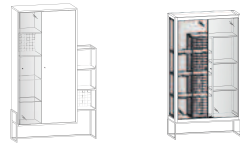

VEN-154100/101\*  
B 119,1 | H 192,6  
T 42,0



VEN-154105  
B 100,0 | H 180,0  
T 42,0

## SIDEBOARDS

Metallsockel



VEN-152100/101\*  
B 148,2 | H 90,6 | T 42,0

VEN-152105/106\*  
B 183,6 | H 90,6 | T 42,0

VEN-152110/111\*  
B 223,6 | H 90,6 | T 42,0

## HIGHBOARDS

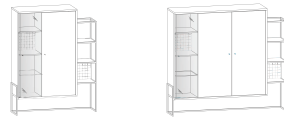

VEN-153100/101\*  
B 119,1 | H 151,8 | T 42,0

VEN-153105/106\*  
B 169,5 | H 151,8 | T 42,0

## HÄNGEELEMENTE



VEN-155100/101\*  
B 180,6 | H 24,8 | T 42,0

VEN-155105/106\*  
B 220,6 | H 24,8 | T 42,0

VEN-155110/111\*  
B 180,6 | H 34,8 | T 42,0

VEN-155115/116\*  
B 220,6 | H 34,8 | T 42,0

VEN-155300/301\*  
B 126,6 | H 36,0 | T 36,0



VEN-155200/201\*  
B 145,2 | H 65,6 | T 42,0

VEN-155205/206\*  
B 180,6 | H 65,6 | T 42,0

VEN-155210/211\*  
B 220,6 | H 65,6 | T 42,0



VEN-155305L/R  
B 32,0 | H 91,0  
T 36,0

VEN-155310L/R  
B 32,0 | H 91,0  
T 36,0

VEN-155315L/R  
B 32,0 | H 120,5  
T 36,0

VEN-155320L/R  
B 32,0 | H 120,5  
T 36,0

VEN-155400/401\*  
B 143,0 | H 140,6 | T 42,0

VEN-155405/406\*  
B 143,0 | H 190,6 | T 42,0

VEN-155410/411\*  
B 143,0 | H 190,6 | T 42,0

Sonderanfertigungen sind teilweise möglich! Alle Maße in cm angegeben \* gespiegelt erhältlich

## BEZÜGE

Alle drei Bezugsarten sind in verschiedenen Farben  
sowie mit Ton-in-Ton-Naht oder Kontrastnaht erhältlich.

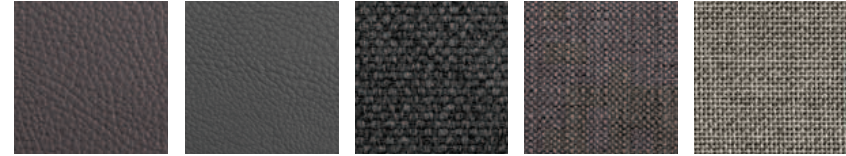

Colorado (Echtleder)

Sixty (Kunstleder)

Impression (Stoff)

Lino (Stoff)

Rovigo (Stoff)



Sand (Stoff)

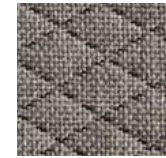

Rombo (Stoff)

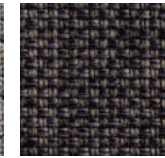

Verano (Stoff)

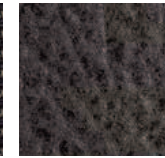

Büffel (Stoff)

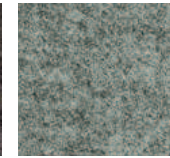

Wool (Stoff)

## WANDELEMENTE

Wandspiegel - optional hinterleuchtet

(Wand)Steckboard



VEN-255100  
B 110,0 | T 2,5  
H 110,0

VEN-255105  
B 110,0 | T 2,5  
H 100,0

VEN-255115  
B 75,0 | T 2,5  
H 75,0



VEN-252100  
B 180,0 | H 5,0 | T 16,0

## BESTECKEINSATZ

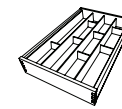

VEN-504100/105/110  
B 44,5/84,5/124,5 | H 6,0 | T 31,5

## KISSEN

Bezug wählbar



VEN-542105  
40,0 x 40,0

## SPEISEN-KOMBINATIONEN

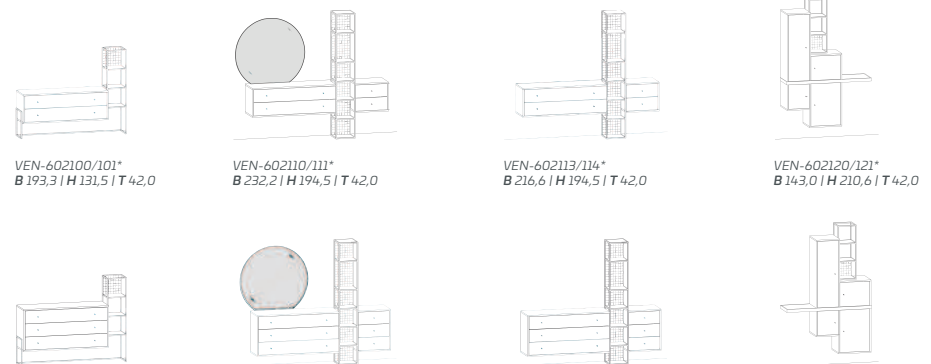

VEN-602100/101\*  
B 193,3 | H 131,5 | T 42,0

VEN-602110/111\*  
B 232,2 | H 194,5 | T 42,0

VEN-602113/114\*  
B 216,6 | H 194,5 | T 42,0

VEN-602120/121\*  
B 143,0 | H 210,6 | T 42,0

VEN-602105/106\*  
B 193,3 | H 131,5 | T 42,0

VEN-602115/116\*  
B 232,2 | H 194,5 | T 42,0

VEN-602118/119\*  
B 216,6 | H 194,5 | T 42,0

VEN-602125/126\*  
B 143,0 | H 210,6 | T 42,0

Sonderanfertigungen sind teilweise möglich! Alle Maße in cm angegeben \* gespiegelt erhältlich

LOWBOARDS

Holzsockel



VEN-151100/101\*  
B 145,2 | H 28,8 | T 55,0



VEN-151105/106\*  
B 180,6 | H 28,8 | T 55,0



VEN-151110/111\*  
B 220,6 | H 28,8 | T 55,0



VEN-151115/116\*  
B 145,2 | H 38,8 | T 55,0



VEN-151120/121\*  
B 180,6 | H 38,8 | T 55,0



VEN-151125/126\*  
B 220,6 | H 38,8 | T 55,0

Metallsockel



VEN-151200/201\*  
B 148,2 | H 49,8 | T 55,0



VEN-151205/206\*  
B 183,6 | H 49,8 | T 55,0



VEN-151210/211\*  
B 223,6 | H 49,8 | T 55,0



VEN-151215/216\*  
B 148,2 | H 59,8 | T 55,0



VEN-151220/221\*  
B 183,6 | H 59,8 | T 55,0



VEN-151225/226\*  
B 223,6 | H 59,8 | T 55,0

COUCHTISCHE



VEN-304100  
L 83,0 | B 80,0  
H 42,0



VEN-304105  
L 123,0 | B 65,0  
H 42,0



VEN-304110  
L 80,0 | B 80,0  
H 42,0



VEN-304115  
L 120,0 | B 65,0  
H 42,0



VEN-309100  
L 36,0 | B 31,0  
H 58,0



VEN-203115  
B 31,0 | H 60,5  
T 31,0



VEN-203120  
B 31,0 | H 90,0  
T 31,0



VEN-203125  
B 31,0 | H 119,5  
T 31,0

WOHNWÄNDE

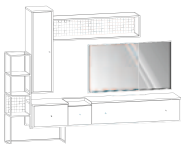

VEN-601100/101\*  
B 251,6 | H 195,3 | T 42,0

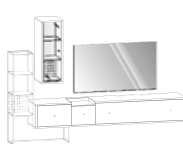

VEN-601105/106\*  
B 251,6 | H 178,8 | T 42,0

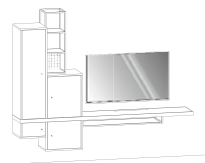

VEN-601110/111\*  
B 258,3 | H 200,6 | T 42,0

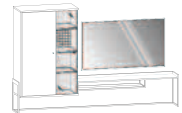

VEN-601115/116\*  
B 239,6 | H 151,8 | T 42,0

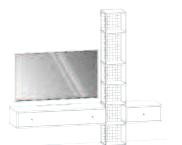

VEN-601125/126\*  
B 216,6 | H 194,5 | T 42,0

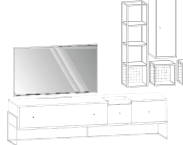

VEN-601135/136\*  
B 282,3 | H 206,8 | T 55,0

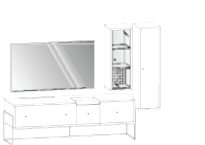

VEN-601140/141\*  
B 224,1 | H 160,8 | T 55,0

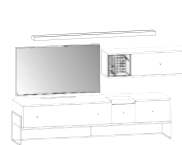

VEN-601145/146\*  
B 261,1 | H 150,8 | T 55,0

REGALE

Standregale



VEN-202100/101\*  
B 120,0 | H 115,5  
T 36,0



VEN-202110/111\*  
B 120,0 | H 145,0  
T 36,0



VEN-202105/106\*  
B 145,0 | H 115,5  
T 36,0



VEN-202115/116\*  
B 145,0 | H 145,0  
T 36,0

Hängeregale



VEN-203100/101\*  
B 90,0 | H 31,0  
T 31,0



VEN-203105  
B 131,0 | H 31,0  
T 31,0



VEN-203110  
B 31,0 | H 31,0  
T 31,0

PFLEGE

Die Natürlichkeit des Holzes in unseren Möbeln widerzuspiegeln liegt uns besonders am Herzen. Grundsätzlich sind unsere Möbel so hochwertig gefertigt, dass sie ein Leben lang halten. Die Schönheit der Möbel wird durch eine sorgfältige Pflege mit unseren natürlichen Pflegemitteln auf lange Zeit erhalten, so dass die Möbel auch nach Jahren wie neu aussehen.



VIDEOS



Pflege, Reinigung und Reparatur von Massivholzmöbeln

[www.wimmer-wohnkollektionen.de/service/videos](http://www.wimmer-wohnkollektionen.de/service/videos)

Unsere Möbel halten, was wir versprechen!

Vom Rohstoff über die Produktion bis hin zur fertigen Kollektion ist es unser Anspruch authentische Möbel auf höchstem Niveau anzubieten. 100 % natürlich, individuell und von bester Qualität.



Wir lassen nichts ans Holz außer Naturöl. So kann das massive Holz atmen, Feuchtigkeit aufnehmen und langsam wieder an die Raumluft abgeben – für ein gesundes, angenehmes Raumklima.



Ein Stück Natur in den eigenen vier Wänden. Typische Wuchsmerkmale, Unregelmäßigkeiten und Asteschlüsse geben dem Holz seinen besonderen Charakter.



Anfertigungen nach Maß gehören zum Standard. Ob Höhen kürzen, Breiten verändern, Tiefen erweitern oder spezielle Einzelanfertigungen – fast alles ist möglich.



Unser Anspruch ist Möbelentwicklung auf höchstem Niveau – mit handwerklichen Details, hochwertigen Markenbeschlägen und fachgerechter Konstruktion.